

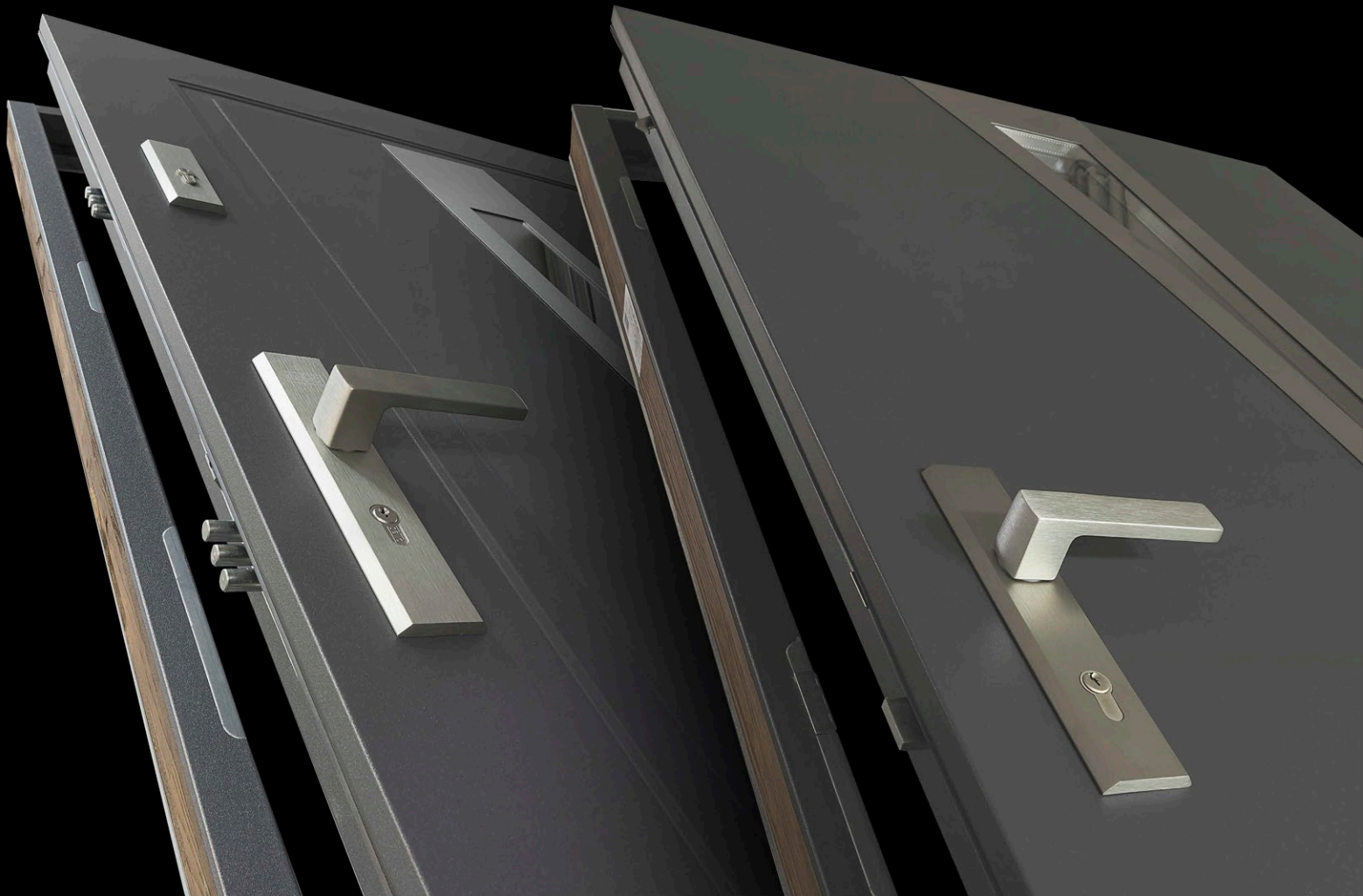

**Homeefe**  
DOORS · WINDOWS · FLOORING



**STEEL DOORS  
CATALOGUE**



Our Homeefe door brand combines beauty and class design, helping our customer get what they want every time. Our leading designers and contractors are focused on providing doors with the highest quality of aesthetics, functionality and most important safety for our clients.

We create and design for people to match their needs and ideas, with our wide range of available products combined with architecture design, attractive prices and materials from which Homeefe doors are made are crucial with much focus on practical, safety and aesthetic details. Their class and beauty is enhanced even further when finished with such accessories as sidelights, bar handles, thresholds and INOX trim.

Our clients sleep easily knowing that their family safety and overall satisfaction will be fully cared for with products such as external steel, anti-burglary and fire-resistant doors, manufactured for houses and residential areas, as well as commercial and industrial buildings. Our products provide effective protection against many threats, with unrevealed product value for quality. Homeefe doors are made providing many years of functionality, durability, resistance to moisture, weather conditions and in result many years anticorrosion qualities. Solid construction and modern design are satisfying the demands of all our customers who care about comfort, safety of their family and acquired taste. Other accessories such as traditional door viewer or digital viewer with LCD screen also meet their requirements.

Our attention to details is also visible in the Homeefe steel door collections: FORTE 92, GRANDE PLUS, GRANDE 68.

These include single and double leaf doors (full and glazed with flat, toughened, frosted, mirror, brown reflex & graphite reflex glass) with thickness from 68mm to 92mm.

All of our beautiful steel doors are manufactured in attractive colours made to much the buildings design such as Golden Oak, Anthracite, Walnut, White.

Our designers, employees and associates at Homeefe are continually providing new improved solutions to meet expectations of our clients and reinforce our brand market recognition, quality and overall price.



page **5**  
**FORTE 92**  
 Flat  
 Thickness 92 mm

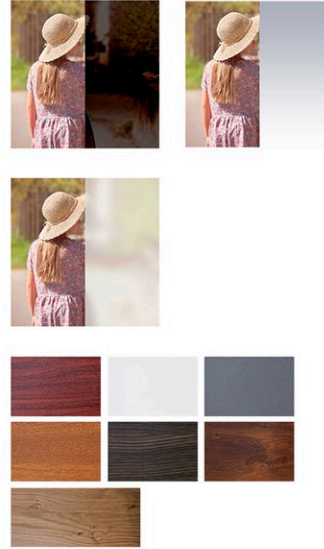

page **33**  
**GLAZING  
 AND  
 COLOURS**



page **11**  
**GRANDE PLUS**  
 Flat  
 Thickness 68 mm



page **35**  
**ENERGO  
 TRANSOMS**  
  
 page **34**  
**SOLIDO  
 TRANSOMS**



page **21**  
**GRANDE 68**  
 Embossed  
 Thickness 68 mm



page **36**  
**TRIM  
 DESIGNS**  
 For flat doors



page **27**  
**GRANDE 68**  
 Flat  
 Thickness 68 mm



page **39**  
**ADDITIONAL  
 ACCESSORIES**

# DOORS 92 mm

COLLECTION FORTE 92

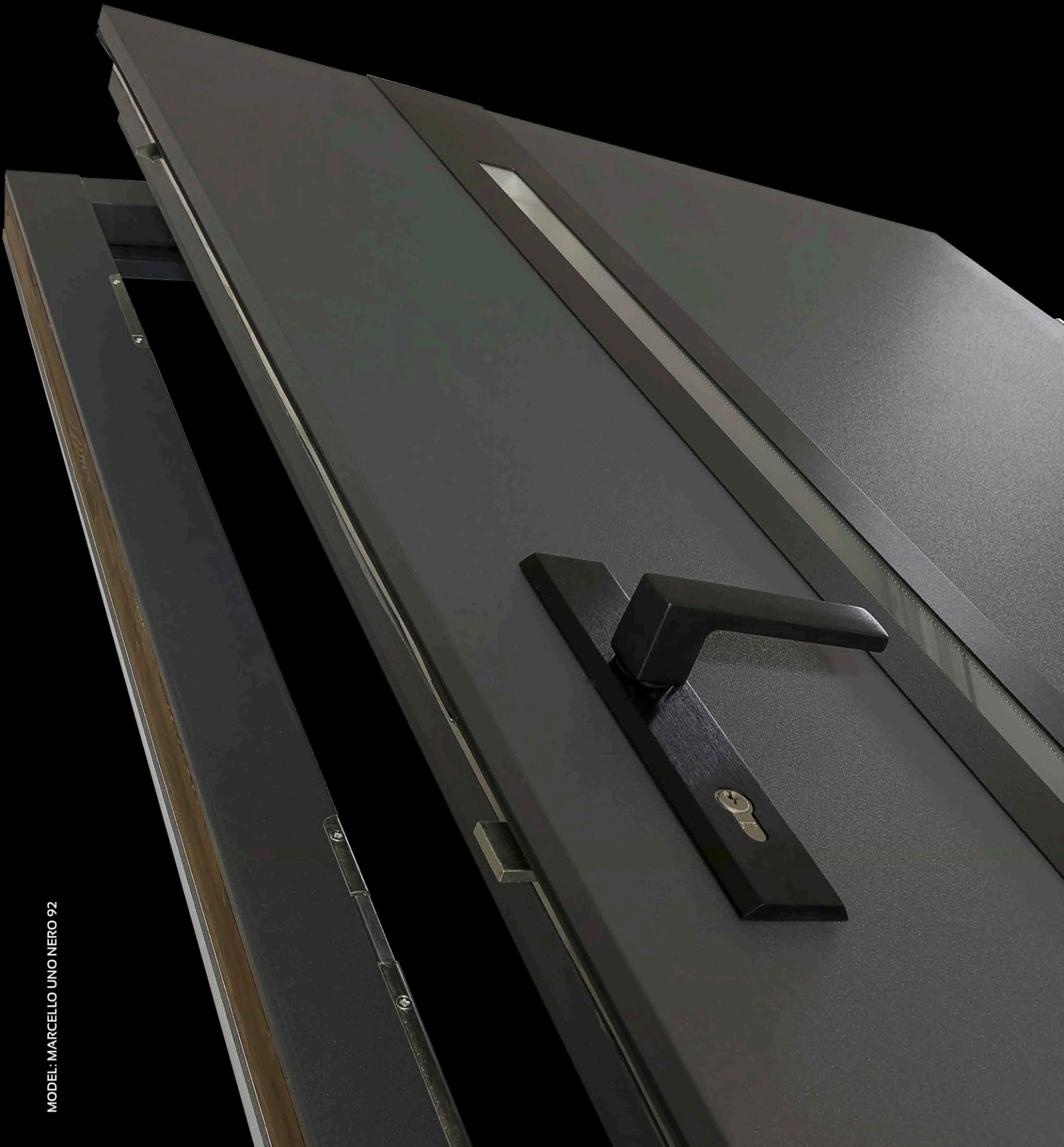

MODEL: MARCELLO UNO NERO 92

# FORTE 92

## SINGLE LEAF FLAT DOOR

### TECHNICAL SPECIFICATION

#### FORTE 92 ( 92 mm ) SINGLE LEAF FLAT DOOR

Door leaf	weight per full 900 mm door	48 kg
	door thickness	92 +/- 1 mm
	filling	PUR foam
	steel sheet thickness	0,7 mm
	coating type	PCV venner
	anti-theft bolts	3
	rebate	4 way
	rebate thickness	19 mm
	rebbet thickness	49 mm
	thermal transmittance	full $\lambda=0,74 \text{ W}/(\text{m}^2 \cdot \text{K})$ glazed $\lambda=1,0 \text{ W}/(\text{m}^2 \cdot \text{K})$
Hinges	type	3D hinge
	coating	white zinc
	class	7
	quantity	3
Lock	hook locking strip with profile cylinder	

 Door thickness **92 mm**

 Door width **90 cm**

**27 dB**  
Noise coefficient 

**0,74 W/(m<sup>2</sup>K)**  
Heat transfer coefficient 

#### CAUTION

The noise and thermal transmittance coefficient applies only when full doors are used as part of a set together with a wood-aluminum frame (ENERGO warm).

#### FORTE 92 ( 92 mm )

Size	Door frame inside width	Door frame inside height	Door + door frame width	Door + door frame height	Doorway width in wall	Doorway height in wall
900 mm	900 mm	2000 mm	1060 mm	2100 mm	1080 mm	2110 mm

We do not shorten this door 

**ENERGO FRAME** 

#### DOOR CONSTRUCTION

The FORTE 92 full or glazed door is made in a rebated version, 92 mm ± 1 mm thick. The outer surface is made of the highest quality hot-dip galvanized steel sheet, covered with PVC veneer. The surface is protected with an additional layer of plastic, which should be removed immediately after door installation. The thermal insulation filling is made of polyurethane foam. The door has a wooden rail mounted around the outside. As standard, the doors are equipped with a Winkhaus hook lock with a spacing of 92 mm for a profile cylinder. The door is fitted with three anti-theft bolts. The standard accessories include a set of INOX or black hinge covers.

The door frame is made of glued pine wood, covered with moulded aluminium and covered with PVC veneer in the colour of the door, with a thermal threshold (aluminium with a plastic insert). A high-quality, pressed-in seal in the door and frame ensures the tightness and quiet operation of the door. The doors are made with a 4-sided rebate system, paired with 3D hinges. These doors are intended for installation externally in residential, commercial and industrial premises. They are resistant to deformation, weather conditions, have a reinforced steel structure and high resistance to moisture.

#### GLAZING

Decorative glazing with INOX stainless steel frames, the structure is brushed and powder coated. Their distinguished style is free from the disruption of corner joins and without frame hole cover caps on the inside. Flat, toughened glass, 92 mm thick, is available in the MIRROR, REFLEX and MILK versions. Ceramic glazing in the DIP panes is made with ceramic digital printing technology, hardened through a toughening process, combined in a package with anti-solar (reflective) glass.

INOX frames should be maintained every six months using a product designed for stainless steel cleaning and maintenance. Hinge covers available in INOX or BLACK colours.

# ACCESSORIES

## STANDARD



# ACCESSORIES

## STANDARD

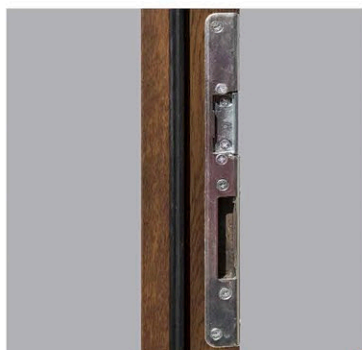

STRIKE LATCH  
ADJUSTMENT

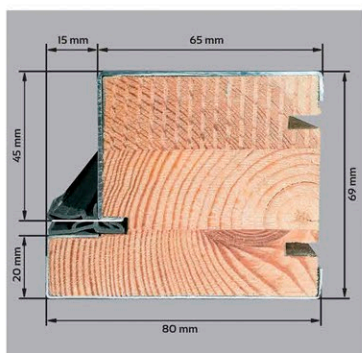

CROSS-SECTION OF  
ENERGO FRAME



3D HINGES

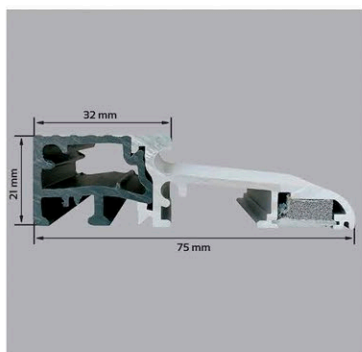

ENERGO THRESHOLD  
WITH THERMAL INSERT



## ENERGO DOOR FRAME

ENERGO  
FRAME



The 92 mm wood-aluminum ENERGO door frame is made of glued pine wood, covered with moulded aluminum and a PVC veneer in the colour of the door leaf, the threshold includes a thermal insert.

### AVAILABLE COLOURS

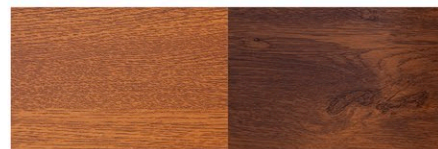

GOLDEN OAK

WALNUT

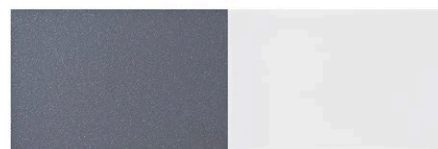

ANTHRACITE

WHITE



Door with ENERGO  
frame cross section

# FORTE 92

## SINGLE LEAF FLAT DOOR

**ENERGO**  
 Warm door frame   
 AS STANDARD

Available with INOX or BLACK decorative Frame

**ENERGO FRAME** 

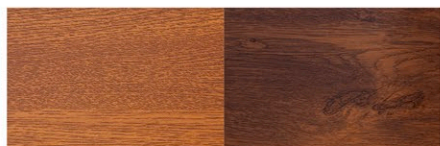

GOLDEN OAK      WALNUT



Door thickness **92 mm**

We do not shorten this door 

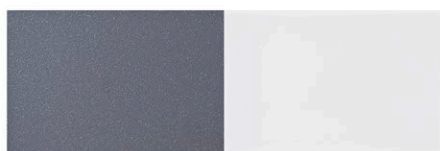

ANTHRACITE      WHITE



Door width **90 cm**



FULL 92



MATTEO NERO 92



MARCELO UNO 92



MARCELO 92



MARCELO UNO NERO 92



FABIO 92



FABIO DIP NERO 92



FABIO UNO 92



DIEGO 92



DIEGO DIP 92





ALFREDO NERO 92



SERGIO 92



SERGIO DIP 92



IVO 92



IVO UNO 92



LUCIANO UNO 92



ENRICO PLUS 92



ENRICO PLUS  
DIP 92



LEONARDO 92



LEONARDO  
DIP 92



AUGUSTO UNO 92

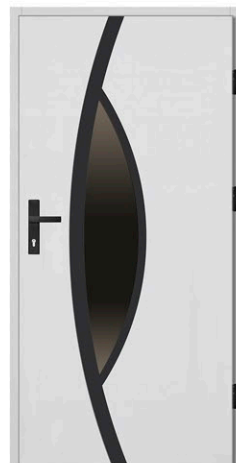

LORENZO  
PLUS NERO 92



LORENZO PLUS  
DIP 92



RICARDO 92

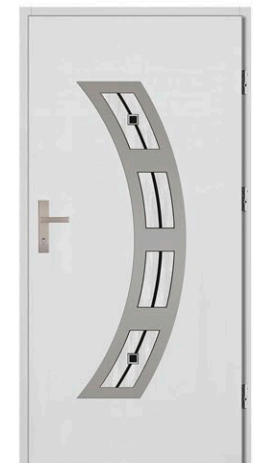

RICARDO DIP 92

# DOORS 68 mm

COLLECTION GRANDE PLUS



MODEL: IVO PLUS

# GRANDE PLUS

## SINGLE LEAF FLAT DOOR

HARDENED ANTI BURGLARY RESISTANCE RC3

### TECHNICAL SPECIFICATION

#### GRANDE PLUS ( 68 mm ) SINGLE LEAF FLAT DOOR

Door leaf	weight per full 900 mm door	41 kg
	door thickness	68 +/- 1 mm
	filling	styrofoam
	steel sheet thickness	0,7 mm
	coating type	wood-effect
	anti-theft bolts	3
	rebate	4 way
	reabate thickness	19 mm
	rabbet thickness	49 mm
	thermal transmittance	full $\lambda=1,1 \text{ W}/(\text{m}^2 \cdot \text{K})$ glazed $\lambda=1,4 \text{ W}/(\text{m}^2 \cdot \text{K})$
	Hinges	type
coating		white galvanized
class		7
quantity		3
Lock	hook locking strip with profile cylinder	

 Door thickness **68** mm

 Door width **90** cm

**29 dB**  
Noise coefficient 

**1,0 W/(m²K)**  
Heat transfer coefficient 

**CAUTION**  
The noise and thermal transmittance coefficient applies only when full doors are used as part of a set together with a wood-aluminum frame (ENERGO warm)

Shortening available up to **70 mm** 

**ATTENTION**  
Shortening available from 45 mm up to 70 mm only

#### GRANDE PLUS ( 68 mm )

Size	Door frame inside width	Door frame inside height	Door + door frame width	Door + door frame height	Doorway width in wall	Doorway height in wall
900 mm	900 mm	2000 mm	1000 mm	2070 mm	1020 mm	2080 mm

### DOOR CONSTRUCTION

The GRANDE PLUS full or glazed doors are made in a rebated version, 68 mm ± 1 mm thick. The outer surface is made of sheet metal, covered with PVC veneer. The surface is protected with an additional layer of plastic, which should be removed immediately after door installation. The thermal insulation filling is made of expanding polystyrene. The door has a wooden rail mounted around the outside and reinforced at the hinges and locks. As standard, the doors are equipped with a Winkhaus hook lock with a spacing of 92 mm for a profile cylinder. The door is fitted with three anti-theft bolts. The door frame is made of galvanized steel sections, covered with wood effect laminate. We recommend buying the ENERGO door frame. A high-quality, pressed-in seal in the door and frame ensures the tightness and quiet operation of the door. The doors are made with a 4-sided rebate system, paired with 3 triple hinges used for burglary resistant doors. These doors are intended for installation externally in residential, commercial and industrial premises. They are resistant to deformation, weather conditions, have a reinforced steel structure and high resistance to moisture.

### GLAZING

Decorative glazing with INOX stainless steel frames, the structure is brushed and powder coated. Their distinguished style is free from the disruption of corner joins and without frame hole cover caps on the inside. Flat, toughened glass, 68 mm thick, is available in the MIRROR, REFLEX and MILK versions. Ceramic glazing in the DIP panes is made with ceramic digital printing technology, hardened through a toughening process, combined in a package with anti-solar (reflective) glass.

INOX frames should be maintained every six months using a product designed for stainless steel cleaning and maintenance.

# ACCESSORIES

## STANDARD



# GRANDE PLUS

## SINGLE LEAF FLAT DOOR

HARDENED ANTI BURGLARY RESISTANCE RC3

**ENERGO**

Warm door frame



AS STANDARD

Available with INOX or BLACK decorative Frame

Shortening available up to 70 mm



**ATTENTION**  
Shortening available from 45 mm up to 70 mm only

Hardened ANTI BURGLARY resistance RC3 door in according with standard PN-EN1627:201 applicable for doors with metal frame, externally opening, with fittings (handle, rosette, cylinder) for the class indicated.

GLAZING for the following designs: SERPENTE PLUS REFLEX, MARCO PLUS REFLEX, VETRO PLUS REFLEX, ARCO PLUS REFLEX, ROMBO PLUS REFLEX only available with REFLEX glazing.



Door thickness 68 mm



Door width 90 cm

**CAUTION**  
RC3 - shortening not available



FULL PLUS



SERPENTE PLUS REFLEX



MARCO PLUS REFLEX



VETRO PLUS REFLEX



DARIO PLUS



DARIO UNO PLUS



PAOLO PLUS



PAOLO UNO PLUS

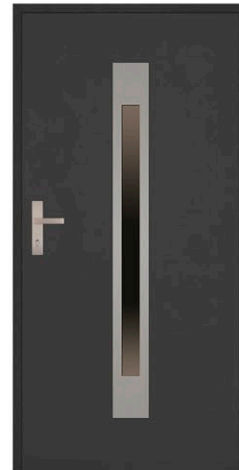

FABIO PLUS



FABIO PLUS DIP

# ACCESSORIES

## ADDITIONAL OPTIONS



3D HINGES



LATCH ADJUSTMENT

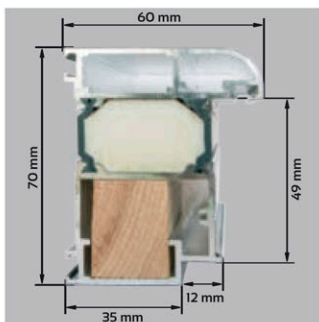

CROSS-SECTION OF TERMO FRAME

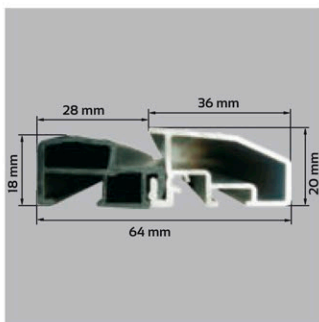

THRESHOLD WITH THERMAL INSERT



## TERMO FRAME RECOMMENDED



The 68 mm aluminum TERMO door is covered with moulded aluminum and a PVC veneer in the colour of the door leaf, the threshold includes a thermal insert and 3D hinges.

## AVAILABLE COLOURS



GOLDEN OAK

WALNUT

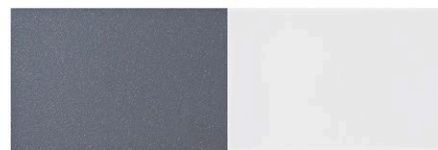

ANTHRACITE

WHITE



BLACK

# ACCESSORIES

## ADDITIONAL OPTIONS



3D HINGES



STRIKE WITH LATCH ADJUSTMENT

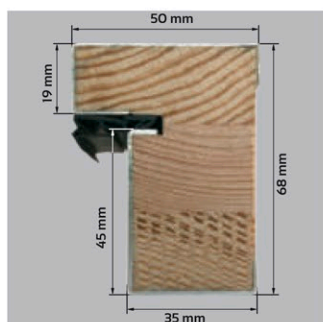

CROSS-SECTION OF ENERGO FRAME

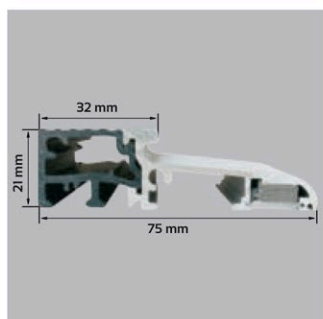

ENERGO THRESHOLD WITH THERMAL INSERT



## ENERGO FRAME RECOMMENDED



The 68 mm wood-aluminum ENERGO door frame is made of glued pine wood, covered with moulded aluminum and a PVC veneer in the colour of the door leaf, the threshold includes a thermal insert.

## AVAILABLE COLOURS

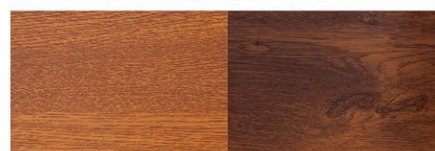

GOLDEN OAK

WALNUT

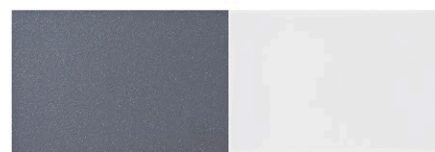

ANTHRACITE

WHITE



Door with ENERGO frame cross section



FABIO PLUS

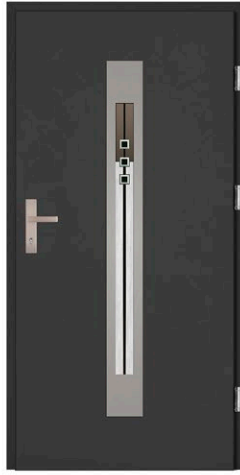

FABIO PLUS DIP



FABIO UNO PLUS



RAFFAELLO PLUS



RAFFAELLO UNO PLUS



ANTONIO PLUS

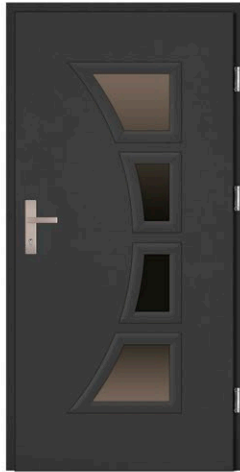

ARCO PLUS REFLEX

till stock lasts



ARCO PLUS DIP

till stock lasts



MARCELLO PLUS



MARCELLO PLUS NERO



MARCELLO UNO PLUS

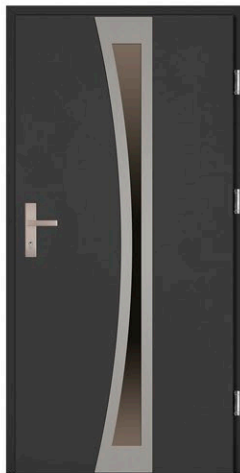

IVO PLUS

till stock lasts



IVO UNO PLUS

till stock lasts



MATTEO PLUS



MATTEO UNO PLUS





ANGELO PLUS



ARMANDO PLUS



LUCIANO  
UNO PLUS

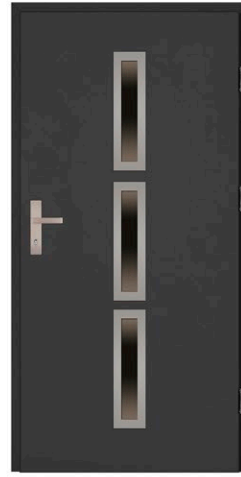

VALENTINO PLUS



VALENTINO  
UNO PLUS

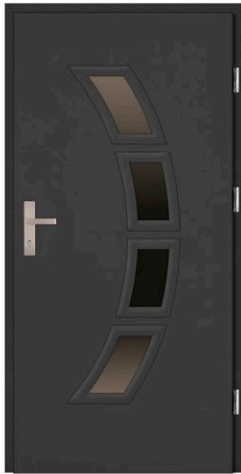

ROMBO  
PLUS REFLEX



ROMBO  
PLUS DIP

till stock lasts

till stock lasts



LEONARDO PLUS

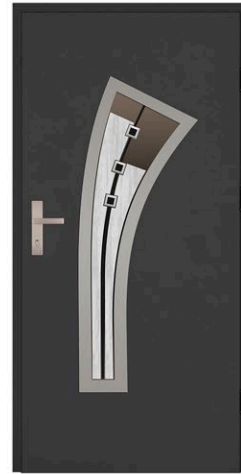

LEONARDO  
PLUS DIP



MARIO PLUS



RINO PLUS



RINO PLUS NERO



RINO PLUS DIP

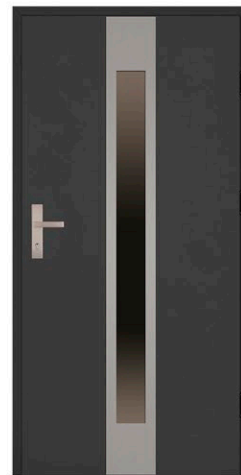

SERGIO PLUS



SERGIO PLUS DIP



DIEGO PLUS

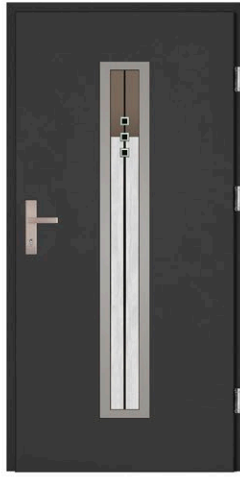

DIEGO PLUS DIP



ERNESTO PLUS

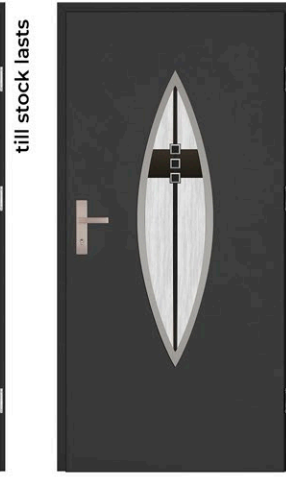

ERNESTO PLUS DIP



RICARDO PLUS

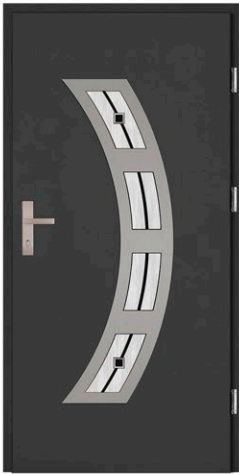
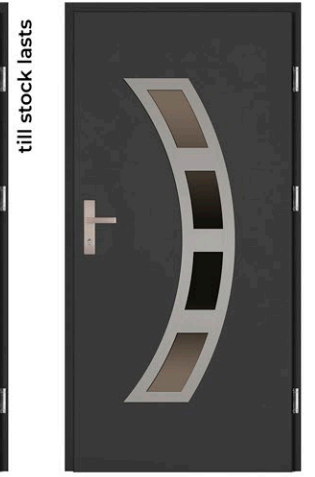
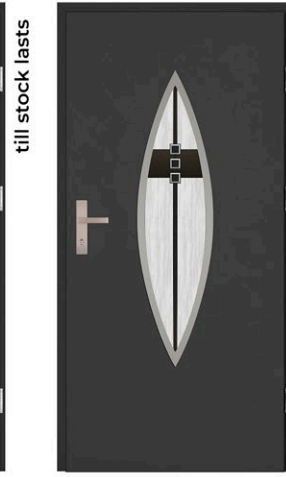

RICARDO PLUS DIP



ENRICO PLUS

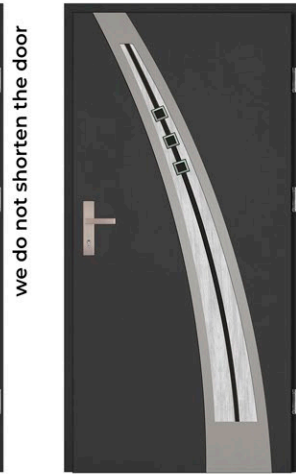

ENRICO PLUS DIP

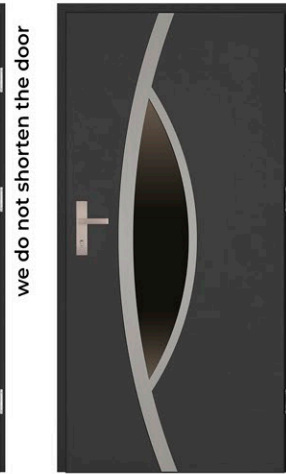

LORENZO PLUS



LORENZO PLUS DIP

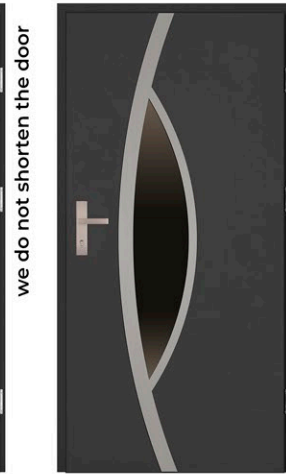

AUGUSTO UNO PLUS



CARLO PLUS NERO



ALBERTO PLUS



FABIO STEP PLUS



FRANCESCO STEP PLUS



# DOORS 68 mm

COLLECTION GRANDE 68, GRANDE 68 FLAT



MODEL: FABIO 68

# GRANDE 68 GRANDE 68 FLAT

HARDENED ANTI BURGLARY RESISTANCE RC2

## TECHNICAL SPECIFICATION

GRANDE, GRANDE 68 FLAT ( 68 mm ) SINGLE LEAF FLAT DOOR

Door leaf	weight per full 900 mm door	26,5 - 28,5 kg
	door thickness	68 +/- 1 mm
	filling	polystyrene $\lambda=0,04$ w/(M2K)
	steel sheet thickness	0,5 - 0,7 mm
	coating type	wood-like
	anti-theft bolts	3
	rebate	4 way
	rebate thickness	15 mm
	rabbet thickness	53 mm
	thermal transmittance	full $\lambda=1,1W/(M2K)$ glazed $\lambda=1,4W/(M2K)$
Hinges	type	triple hinge
	coating	white zinc
	class	7
	quantity	3
Lock	standard 3-bolt	lock with profile cylinder
	additional 3-bolt	lock with profile cylinder

1,0 W/(m<sup>2</sup>K)  
Heat transfer  
coefficient



29 dB  
Noise  
coefficient



**CAUTION**  
The noise and thermal transmittance coefficient applies only when full doors are used as part of a set together with a wood-aluminum frame (ENERGO warm)

Shortening  
available up to  
70 mm



**ATTENTION**  
Shortening available from 45 mm up to 70 mm only

GRANDE, GRANDE 68 FLAT ( 68 mm )

Size	Door frame inside width	Door frame inside height	Door + door frame width	Door + door frame height	Doorway width in wall	Doorway width in wall
800 N	780 mm	1980 mm	880 mm	2050 mm	900 mm	2060 mm
900	900 mm	2000 mm	1000 mm	2070 mm	1020 mm	2080 mm
1000	1000 mm	2000 mm	1100 mm	2070 mm	1120 mm	2080 mm



### DOOR CONSTRUCTION

The GRANDE 68, GRANDE 68 FLAT full or glazed doors are made in a rebated version, 68 mm ± 1 mm thick. The outer surface is made of the highest quality hot-dip galvanized sheet metal, covered with PVC veneer. The surface is protected with an additional layer of plastic, which should be removed immediately after door installation. The thermal insulation filling is made of expanding polystyrene. The door has a wooden rail mounted around the outside and reinforced at the hinges and locks. As standard, the doors are equipped with two 3-bolt locks with a profile cylinder. The door is fitted with three anti-theft bolts. The door frame is made of galvanized steel sections, covered with wood effect laminate. We recommend buying the ENERGO door frame. A high-quality, pressed-in seal in the door and frame ensures the tightness and quiet operation of the door. The doors are made with a 4-sided rebate system, paired with 3 triple hinges used for burglary resistant doors. These doors are intended for installation externally in residential, commercial and industrial premises. They are resistant to deformation, weather conditions, have a reinforced steel structure and high resistance to moisture.

### GLAZING

Decorative glazing with INOX stainless steel frames, the structure is brushed and powder coated. Their distinguished style is free from the disruption of corner joins and without frame hole cover caps on the inside. Flat, toughened glass, 68 mm thick, is available in the MIRROR, REFLEX and MILK versions. Ceramic glazing in the DIP panes is made with ceramic digital printing technology, hardened through a toughening process, combined in a package with anti-solar (reflective) glass.

INOX frames should be maintained every six months using a product designed for stainless steel cleaning and maintenance.

# ACCESSORIES

## STANDARD

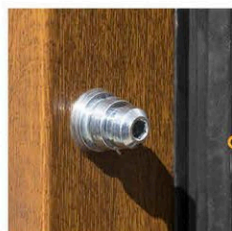

HINGE BOLTS  
(3 PIECES)

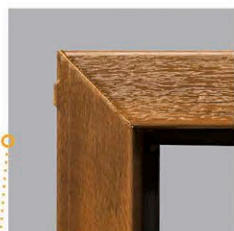

METAL DOOR  
FRAME WITH SEAL

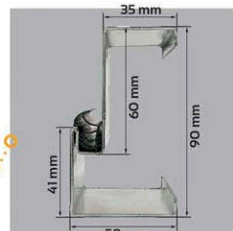

CROSS-SECTION OF  
SYMMETRICAL  
FRAME WITH SEAL

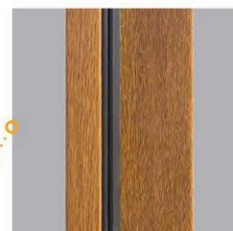

DOOR LEAF  
THICKNESS 68 mm

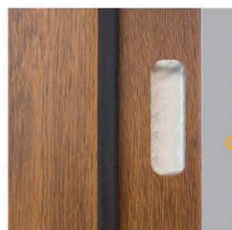

UPPER LOCK  
STRIKE

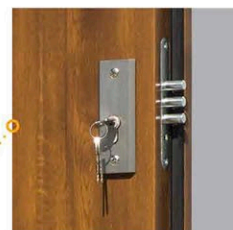

UPPER LOCK

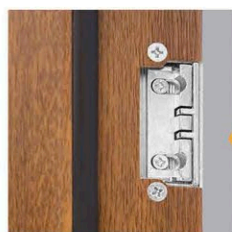

STRIKE WITH LATCH  
ADJUSTMENT

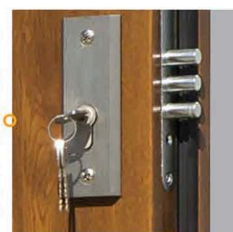

ESPAÑOLETTE  
LOCK WITH SEAL

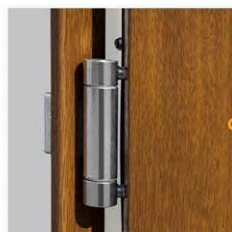

TRIPLE HINGE  
(3 PIECES)

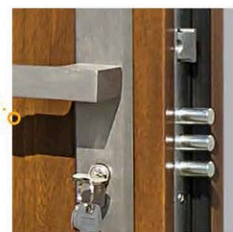

LOWER  
LOCK



DOOR FRAME  
BOLT COVERS



SETTO VDV DOOR  
HANDLE WITH  
CYLINDER AND  
ONE KEY SYSTEM

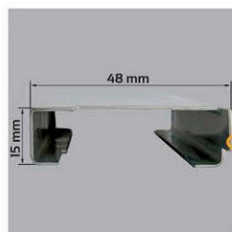

STAINLES SSTEEL  
THRESHOLD



DOOR LEAF WITH  
4-SIDED REBATE

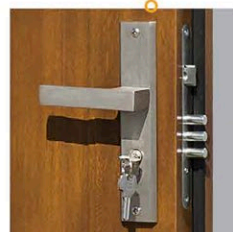

HAGA VDV DOOR  
HANDLE WITH CYLINDER  
AND ONE KEY SYSTEM

# ACCESSORIES

## ADDITIONAL OPTIONS



3D HINGES

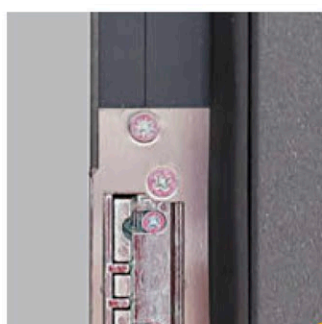

LATCH ADJUSTMENT

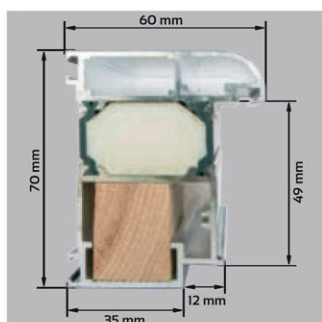

TERMO FRAME CROSS SECTION

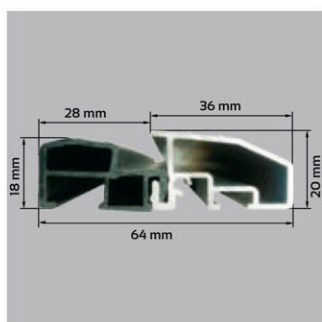

THRESHOLD WITH THERMAL INSERT



## TERMO FRAME

ALUMINUM DOOR FRAME



The 68 mm aluminium TERMO door frame is made out of moulded aluminium covered PCV veneer in the colour of the door leaf, the threshold includes a thermal insert and 3D hinges

### AVAILABLE COLOURS

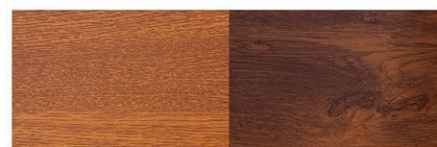

GOLDEN OAK

WALNUT

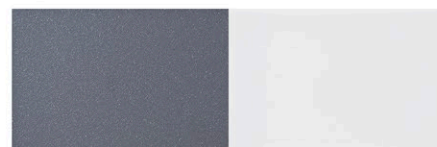

ANTHRACITE

WHITE

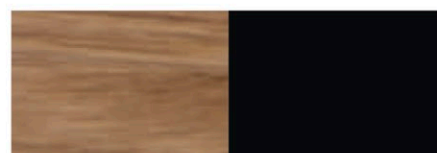

WINCHESTER

BLACK

# ACCESSORIES

## ADDITIONAL OPTIONS



THREE-PART  
HINGE



STRIKE WITH  
LATCH ADJUSTMENT

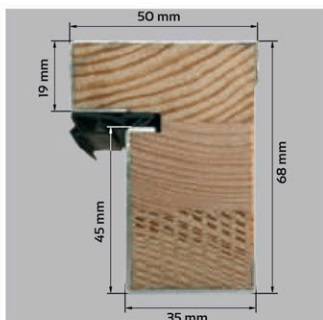

CROSS-SECTION OF  
ENERGO FRAME

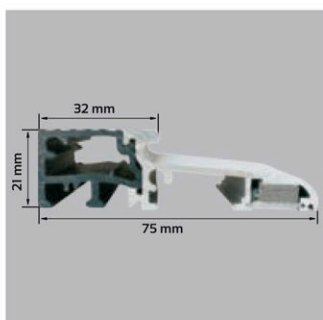

ENERGO THRESHOLD  
WITH THERMAL INSERT

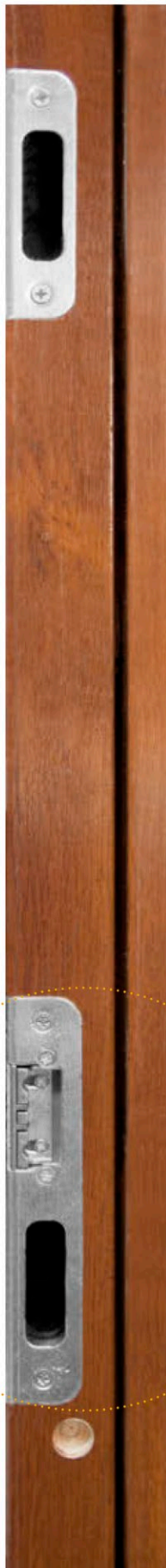

## ENERGO FRAME RECOMMENDED



The 68 mm wood-aluminum ENERGO door frame is made of glued pine wood, covered with moulded aluminum and a PVC veneer in the colour of the door leaf, the threshold includes a thermal insert.

### AVAILABLE COLOURS

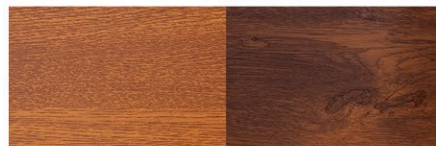

GOLDEN OAK

WALNUT

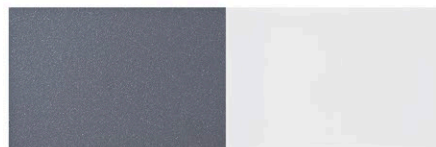

ANTHRACITE

WHITE



Door with ENERGO  
frame cross section

# GRANDE 68

## SINGLE LEAF EMBOSSED DOOR

HARDENED ANTI BURGLARY RESISTANCE RC2

**ENERGO**

Warm door frame



Recommended

Available with INOX or BLACK decorative Frame

Hardened ANTI BURGLARY resistance RC2 door accord with standard PN-EN1627:201 applicable for doors with a metal frame, externally opening, with fittings (handle, rosette, cylinder) for the class indicated

GLAZING for the following designs: VETRO 68 REFLEX, SERPENTE 68, ARCO 68 REFLEX, MARCO 68 REFLEX, ROMBO 68 REFLEX only available with REFLEX glazing.

Door thickness 68 mm

Door thickness 90 mm

800N  
900,1000 mm

Shortening available up to 70 mm



ATTENTION Shortening available from 45 mm up to 70 mm only RC2 - shortening not available

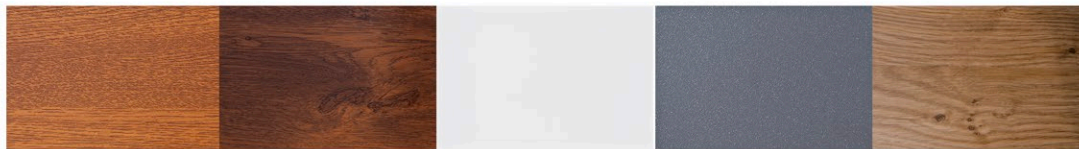

GOLDEN OAK

WALNUT

WHITE

ANTHRACITE

WINCHESTER

Winchester colour only available for doors with INOX and NERO surrounds and 800,900 mm Metal Frame



W16 FULL 68

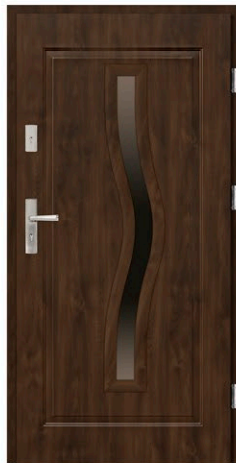

SERPENTE 68 REFLEX

till stock lasts



VERTE 68 REFLEX

till stock lasts



MARCO 68 REFLEX

till stock lasts



DARIO 68



DARIO 68 NERO



DARIO UNO 68



RAFFAELLO 68



RAFFAELLO UNO 68



RAFFAELLO 68





FABIO 68 DIP

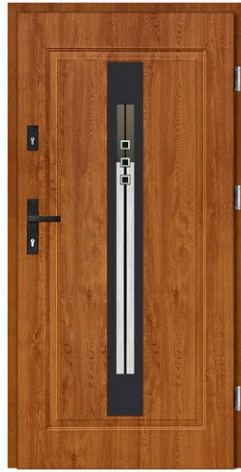

FABIO 68 DIP NERO



FABIO UNO 68



ARMANDO 68



ANGELO 68



RINO 68



RINO 68 DIP

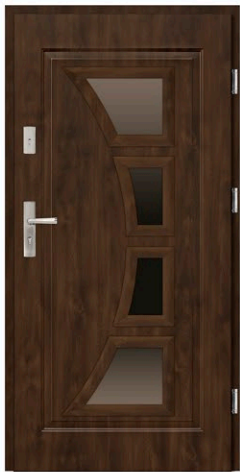

ARCO 68 REFLEX



ARCO 68 DIP



DIEGO 68



DIEGO 68 DIP



DIEGO 68 DIP NEGRO

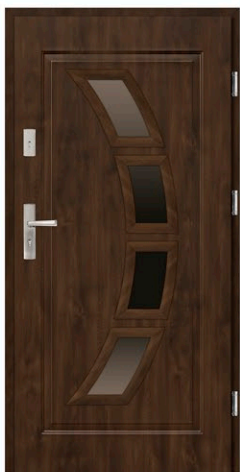

ROMBO 68 REFLEX



ROMBO 68 DIP



RICARDO 68

# GRANDE 68

## SINGLE LEAF EMBOSSED DOOR

HARDENED ANTI BURGLARY RESISTANCE RC2

**ENERGO**  
 Warm door frame   
 Recommended

Available with INOX or BLACK decorative Frame



Shortening available up to 70 mm 

ATTENTION Shortening available from 45 mm up to 70 mm only

**ENERGO FRAME** 

Price for ENERGO door frame 800, 900 and 1000 mm

 Door thickness 68 mm

 Door width 90 cm

800N  
 900,1000 mm

RAFFAELLO UNO 68



PAOLO 68



PAOLO 68 NERO



PAOLO 68 UNO



ANTONIO 68



LEONARDO 68



LEONARDO 68 DIP



FABIO 68

# GRANDE 68

## SINGLE LEAF EMBOSSED DOOR

HARDENED ANTI BURGLARY RESISTANCE RC3

**ENERGO**

Warm door frame



Recommended

Available with INOX or BLACK decorative Frame

**ENERGO FRAME**



Shortening available up to 70 mm



Door thickness 68 mm



Door width 90 cm

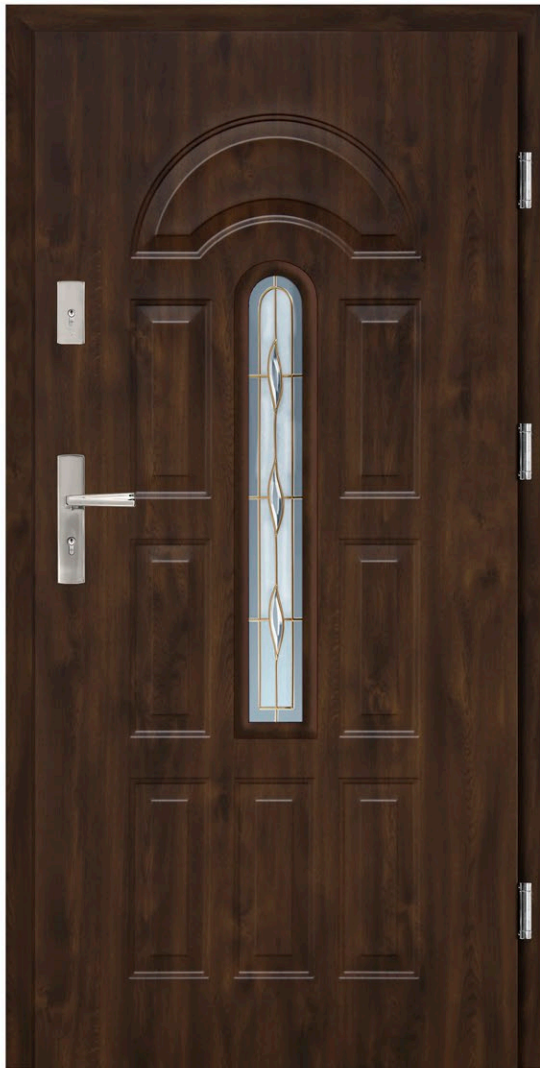

W3 68 L2



W3 FULL

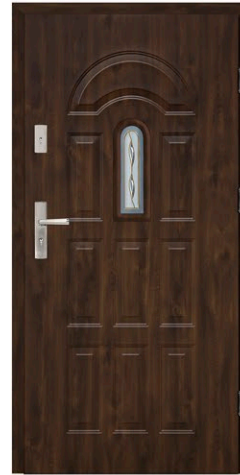

W3 68 L1



W3 68 J



RICARDO 68 DIP



ERNESTO 68

till stock lasts



ERNESTO 68 DIP

till stock lasts



MARIO 68



LORENZO 68



LORENZO 68 NERO



LORENZO 68 DIP



ENRICO 68 DIP

# GRANDE 68 FLAT

## SINGLE LEAF FLAT DOOR

HARDENED ANTI BURGLARY RESISTANCE RC2

**ENERGO**

Warm door frame



Recommended

Available with INOX or BLACK decorative Frame

Shortening available up to 70 mm



**ATTENTION**  
Shortening available from 45 mm up to 70 mm only

**ENERGO FRAME**



Door thickness 68 mm



Door width

800N, 900 mm

Hardened ANTI BURGLARY resistance RC2 in accord with standard PN-EN1627:201 applicable for doors with a metal frame, externally opening, with fittings (handle, rosette, cylinder) for the class indicated

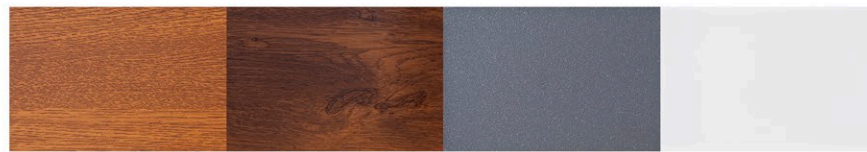

GOLDEN OAK

WALNUT

ANTHRACITE

WHITE

GLAZING for the following designs: SERPENTE REFLEX FLAT, MARCO REFLEX FLAT, VETRO REFLEX FLAT, ARCO REFLEX FLAT, ROMBO REFLEX FLAT, only available with REFLEX glazing.



FULL FLAT



SERPENTE REFLEX FLAT

till stock lasts

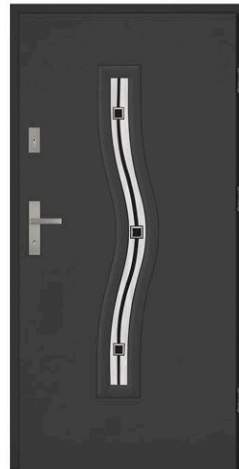

SERPENTE DIP FLAT

till stock lasts



MARCO REFLEX FLAT

till stock lasts



VETRO REFLEX FLAT

till stock lasts



VETRO DIP FLAT

till stock lasts



DARIO FLAT



DARIO UNO FLAT

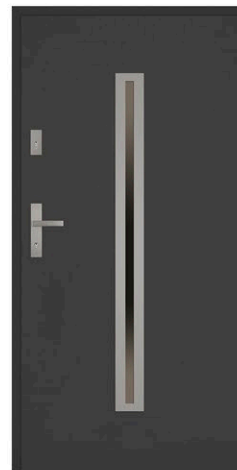

PAOLO FLAT



PAOLO UNO FLAT



FABIO FLAT



FABIO UNO FLAT



FABIO DIP NERO  
FLAT



RAFFAELLO FLAT



RAFFAELLO UNO  
FLAT



ANTONIO FLAT



ARCO REFLEX  
FLAT



ARCO DIP FLAT

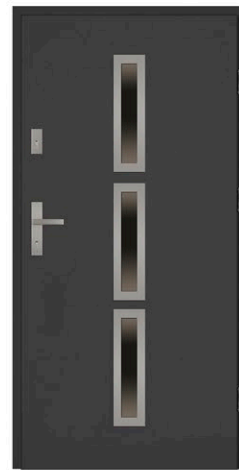

VALENTINO FLAT



VALENTINO UNO  
FLAT



ROMBO REFLEX  
FLAT

till stock lasts



ROMBO DIP  
FLAT

till stock lasts



RINO FLAT



RINO DIP FLAT



MARIO FLAT



only in size 900 mm

**MATTEO FLAT**



only in size 900 mm

**MATTEO UNO FLAT**



we do not shorten the door / only in size 900 mm

**IVO FLAT**



we do not shorten the door / only in size 900 mm

**IVO UNO FLAT**



we do not shorten the door

**ALFREDO NERO FLAT**



only in size 900 mm

**MARCELLO FLAT**



only in size 900 mm

**MARCELLO NERO FLAT**



only in size 900 mm

**MARCELLO NERO UNO FLAT**



**DIEGO FLAT**



**DIEGO DIP FLAT**



only in size 900 mm

**LUCIANO NERO FLAT**



only in size 900 mm

**LUCIANO UNO NERO FLAT**



only in size 900 mm

**SERGIO FLAT**



**SERGIO DIP FLAT**



only in size 900 mm

**ANGELO FLAT**



ARMANDO FLAT



LEONARDO FLAT



LEONARDO DIP FLAT



LORENZO PLUS FLAT

only in size 900 mm



LORENZO PLUS DIP FLAT

only in size 900 mm



ENRICO PLUS FLAT

we do not shorten the door / only in size 900 mm



ENRICO PLUS DIP FLAT

we do not shorten the door / only in size 900 mm



RICARDO FLAT

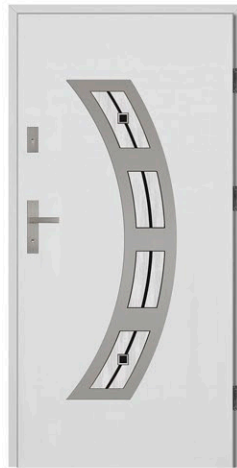

RICARDO DIP FLAT



ERNESTO FLAT

till stock lasts

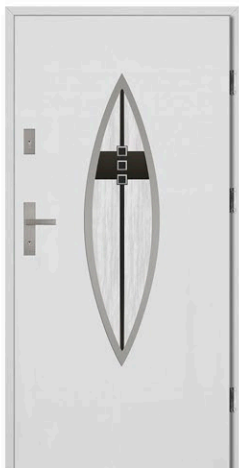

ERNESTO DIP FLAT

till stock lasts



AUGUSTO UNO FLAT

we do not shorten the door / only in size 900 mm



CARLO NERO FLAT



FABIO STEP FLAT

we do not shorten the door / only in size 900 mm



FRANCESCO STEP FLAT

only in size 900 mm

# GLAZING

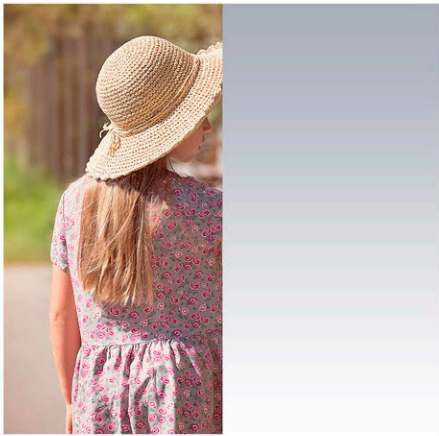

MIRROR GLASS

At any time of the day or night, the glass looks like a silver mirror from both the outside and inside



MILK GLASS

Frosted glass that stands out from other glazing types: milk white, opaque, provides privacy and is easy to clean

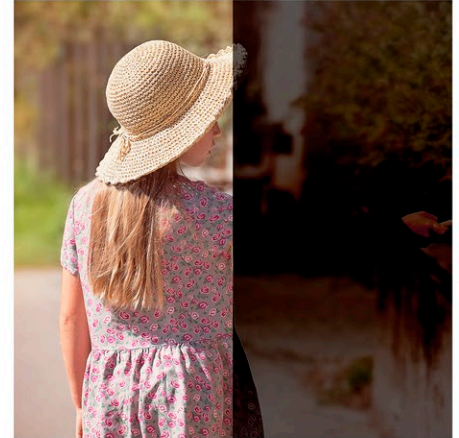

REFLEX GLASS

A delicate, subtle reflection ('halfmirror' effect) with a brown shade (brown tint glass). See-through from both sides

# AVAILABLE COLOURS



ANTHRACITE

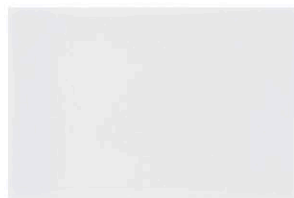

WHITE

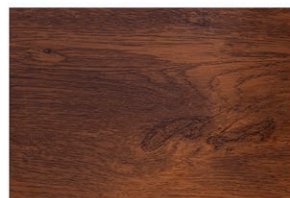

WALNUT



GOLDEN OAK

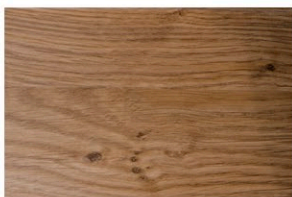

WINCHESTER

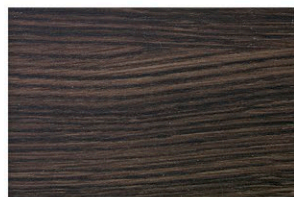

WENGE

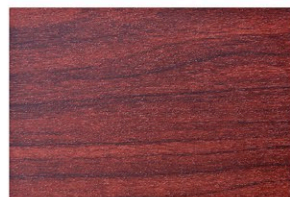

MAHOGANY



# SOLIDO TRANSOMS

## FOR DOOR LEAF THICKNESS 56MM

We do not shorten this door



TRANSOM is made with an aluminium profile



SIDE TRANSOM WIDTH  
200-1000 mm



TOP TRANSOM HEIGHT  
200-700 mm

SET PRICE = chosen door model with aluminium SOLIDO frame  
+ side transom 200, 300, 400, 500, 600, 700, 800, 900, 1000 mm  
+ top transom 200, 300, 400, 500, 600, 700 mm

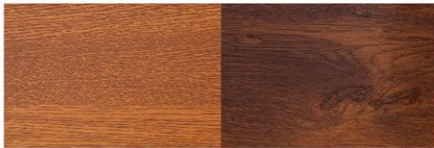

GOLDEN OAK      WALNUT

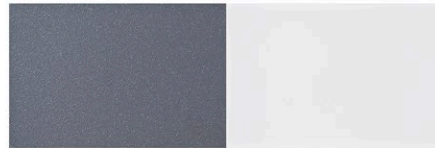

ANTHRACITE      WHITE

### AVAILABLE GLAZING



MILK GLASS



REFLEX GLASS



MIRROR GLASS



Door thickness

68 mm

GRANDE 68  
GRANDE 68  
FLAT



- 1 ALUMINIUM PROFILE
- 2 INSULATION FILLING
- 3 3 PANE UNIT

# ENERGO TRANSOMS

We do not shorten this door



Transoms are made using ENERGO technology with wood-aluminium profiles



SIDE TRANSOM WIDTH

200, 300  
400, 500 mm



TOP TRANSOM HEIGHT

200, 300  
400, 500 mm

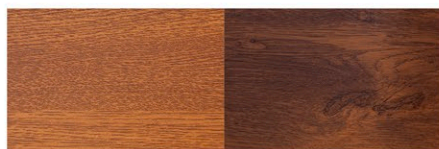

GOLDEN OAK

WALNUT

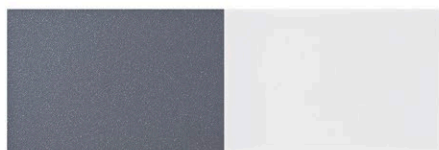

ANTHRACITE

WHITE

SET PRICE = chosen door model with wood-aluminium frame  
+ side transom 200, 300, 400, 500 mm  
+ top transom 200, 300, 400, 500 mm  
+ top transom 200, 300, 400, 500 mm  
width up to 1100 mm  
width from 1100 to 1500 mm  
width from 1500 to 2000 mm  
Irregular transom sizes – additional 25% charge

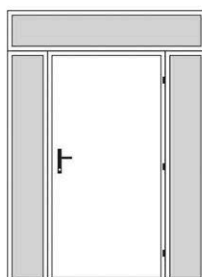

NLPG

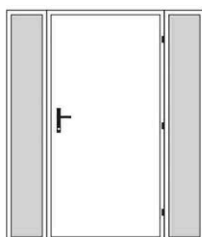

NLP

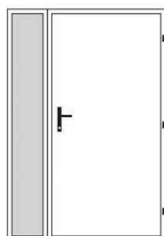

NL

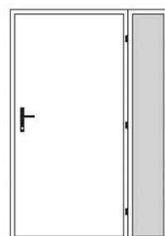

NP



MILK GLASS



REFLEX GLASS

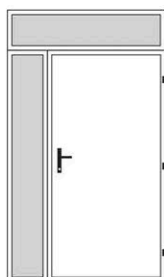

NLG

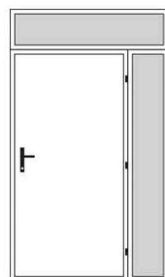

NPG

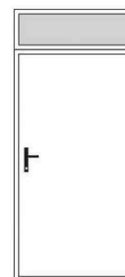

NG



MIRROR GLASS



**FORTE 92**

Door thickness

92 mm



**GRANDE 68  
GRANDE 68  
FLAT  
GRANDE 68  
PLUS**

Door thickness

68 mm

# DOOR TRIM DESIGNS

ADDITIONAL COST PER FULL DOOR SET

FOR SINGLE LEAF FLAT DOOR IN COLLECTIONS:  
FORTE 92, GRANDE PLUS, GRANDE 68 FLAT, CLASSICO



Door thickness  
68, 92 mm



Door width 800,  
900, 1000 mm



DESIGN 1



DESIGN 2



DESIGN 3



DESIGN 4



DESIGN 5



DESIGN 6



DESIGN 7

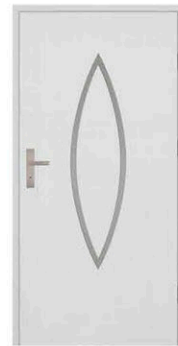

ERNESTO  
DESIGN



ARMANDO  
DESIGN



ANGELO  
DESIGN



ANGELO 5  
DESIGN



VALENTINO  
DESIGN



VALENTINO  
UNO DESIGN



ALFREDO  
DESIGN



ALBERTO  
DESIGN



RINO  
DESIGN



PAOLO  
DESIGN



PAOLO UNO  
DESIGN



DIEGO  
DESIGN



DARIO  
DESIGN



FABIO DESIGN



FABIO UNO DESIGN



SERGIO DESIGN



MATTEO DESIGN



MATTEO UNO DESIGN



MARCELLO DESIGN



MARCELLO UNO DESIGN



LORENZO PLUS DESIGN



LORENZO DESIGN



MARIO DESIGN



RAFFAELLO DESIGN



RAFFAELLO UNO DESIGN



IVO DESIGN

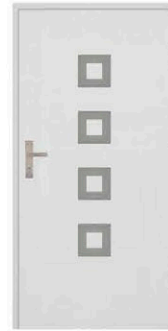

CARLO DESIGN



RICARDO DESIGN



LEONARDO DESIGN



ENRICO PLUS DESIGN



ENRICO DESIGN



ANTONIO DESIGN



LUCIANO UNO DESIGN

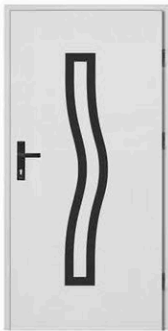

RINO NERO DESIGN

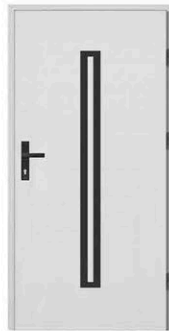

PAOLO NERO DESIGN

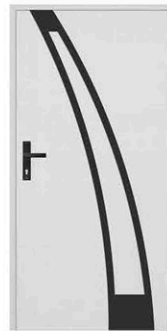

ENRICO PLUS NERO DESIGN



MATTEO NERO DESIGN

TRIM DESIGNS  
available in  
INOX or  
BLACK COLOUR

# INTEGRATED HANDLES

NEW QUALITY OF SETTO VDV AND HAGA VDV FITTINGS



## FASTER INSTALLATION

Handle integrated with plate -two screw kit assembly as the integrated handle is installed by fixing only 2 screws. An additional help is the universal properties of the handle - it doesn't matter whether the door is right or left handed, because the Setto VDV and Haga VDV handles are suitable for both.



## EASIER TO OPERATE

Universal assistance for left and right hand doors due to the integration of elements, there is no need for a pressure screw which previously commonly caused difficulties with operation



## RELIABILITY

Minimised risk of handle coming loose or dropping no need to use a pressure screw which improves reliability, thanks to this the new integrated handles are ideal for rooms with high traffic.



SETTO VDV and HAGA VDV integrated handles are suitable for left and right doors. Low degree of deformation with a load of 1000N > 0.75mm. Possible spacing of 72 mm and 92 mm. 2 fastening screws in hardened sleeves, not accessible from the outside. Suitable for doors with a thickness of 68 mm to 92 mm. A significantly thicker and stronger spring located in the handle.

# ACCESSORIES

ADDITIONAL OPTIONS

72MM HANDLES FOR THE FOLLOWING DOOR RANGES: GRANDE 68, GRANDE 68 FLAT, MODERN, CLASSICO, J-TITANIUM, J-PLATINIUM, JW3, JW4, ECO-TECHNIC



SETTO VDV  
COLOUR:  
INOX, PLATINIUM  
£ 66<sup>00</sup>



SETTO VDV  
COLOUR:  
BLACK  
£ 75<sup>00</sup>



HAGA VDV  
COLOUR:  
INOX, PLATINIUM  
£ 66<sup>00</sup>



HAGA VDV  
COLOUR:  
BLACK  
£ 75<sup>00</sup>



TOPAZ  
COLOUR:  
NICKEL  
£ 30<sup>50</sup>



METRO  
COLOUR:  
NICKEL  
£ 51<sup>50</sup>



SETTO  
ROSETTE  
COLOUR:  
INOX, PLATINIUM  
£ 24<sup>50</sup>



SETTO  
ROSETTE  
COLOUR:  
BLACK  
£ 28<sup>50</sup>



SETTO  
HAGA  
COLOUR:  
INOX, PLATINIUM  
£ 24<sup>50</sup>



SETTO  
HAGA  
COLOUR:  
BLACK  
£ 28<sup>50</sup>



ROSETTE  
TOPAZ  
COLOUR:  
NICKEL  
£ 10<sup>00</sup>



ROSETTE  
METRO  
COLOUR:  
NICKEL  
£ 25<sup>00</sup>



GRANDE RC2  
COLOUR:  
INOX  
£ 73<sup>50</sup>



GRANDE RC2  
COLOUR:  
BLACK  
£ 81<sup>50</sup>



SLIM SOLO  
COLOUR:  
INOX  
£ 56<sup>00</sup>



SLIM SOLO  
COLOUR:  
BLACK  
£ 63<sup>50</sup>



HANDLE FOR  
ECO-TECHNIC DOOR  
COLOUR:  
BLACK  
£ 10<sup>00</sup>



ROSETTE  
GRANDE RC2  
COLOUR:  
INOX  
£ 32<sup>00</sup>



ROSETTE  
GRANDE RC2  
COLOUR:  
BLACK  
£ 35<sup>50</sup>



ROSETTE  
SLIM SOLO  
COLOUR:  
INOX  
£ 33<sup>00</sup>



ROSETTE  
SLIM SOLO  
COLOUR:  
BLACK  
£ 37<sup>00</sup>

# ACCESSORIES

ADDITIONAL OPTIONS

92MM HANDLES FOR THE FOLLOWING DOOR RANGES:  
FORTE 92, GRANDE PLUS



SETTO VDV  
COLOUR:  
INOX, PATINA  
£ 63<sup>00</sup>



SETTO VDV  
COLOUR:  
BLACK  
£ 71<sup>00</sup>



HAGA VDV  
COLOUR:  
INOX, PATINA  
£ 63<sup>00</sup>



HAGA VDV  
COLOUR:  
BLACK  
£ 71<sup>00</sup>



SETTO PULL  
HANDLE  
COLOUR: INOX  
£ 67<sup>50</sup>



SETTO PULL  
HANDLE  
COLOUR: BLACK  
£ 75<sup>50</sup>



HAGA PULL  
HANDLE  
COLOUR: INOX  
£ 67<sup>50</sup>



HAGA PULL  
HANDLE  
COLOUR: BLACK  
£ 75<sup>50</sup>



GRANDE RC3  
COLOUR: INOX  
£ 116<sup>00</sup>



GRANDE RC3  
COLOUR: BLACK  
£ 140<sup>50</sup>



SLIM SOLO  
COLOUR: INOX  
£ 53<sup>50</sup>



SLIM SOLO  
COLOUR: BLACK  
£ 60<sup>50</sup>



SOLO HANDLE  
DEDICATED FOR  
PULL HANDLE  
COLOUR: INOX  
£ 66<sup>50</sup>



SOLO HANDLE  
DEDICATED FOR  
PULL HANDLE  
COLOUR: BLACK  
£ 75<sup>00</sup>

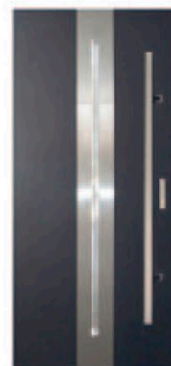

EXTERIOR  
SIDE

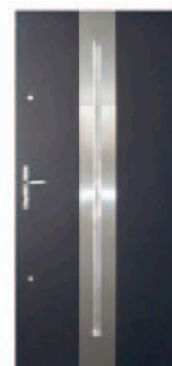

EXAMPLE  
PHOTO OF  
SETTO SOLO  
ACCESSORIES  
WITH PULL  
HANDLE

INTERIOR  
SIDE

# ACCESSORIES

ADDITIONAL OPTIONS



CYLINDER INSERT 26/43  
COLOUR: NICKEL, PATINA FOR DOOR  
THICKNESS: 41, 46MM

£ 10<sup>00</sup>

CYLINDER INSERT 30/50  
COLOUR: NICKEL, PATINA FOR DOOR  
THICKNESS: 56MM

£ 12<sup>00</sup>

CYLINDER INSERT 40/50  
COLOUR NICKEL, PATINA FOR DOOR  
THICKNESS: 68MM (GRANDE)

£ 14<sup>50</sup>



ONE KEY SYSTEM CLASS C  
NICKEL, BRASS CYLINDER INSERT+  
CYLINDER INSERT-KNOB  
FOR DOOR THICKNESS 56MM  
SIZE 30/50

£ 110<sup>50</sup>

ONE KEY SYSTEM CLASS C  
NICKEL, BRASS CYLINDER INSERT+  
CYLINDER INSERT-KNOB  
FOR DOOR THICKNESS 68MM  
SIZE 40/50

£ 118<sup>50</sup>

HOME SECURITY



DIGITAL DOOR VIEWER  
WITH 3.2" LCD SCREEN  
AND INFRARED CAMERA,  
STORES UP TO 50  
PHOTOS

£ 193<sup>50</sup>



ONE KEY SYSTEM  
NICKEL, BRASS CYLINDER INSERT+  
CYLINDER INSERT-KNOB  
FOR DOOR THICKNESS 56MM  
SIZE 30/50

£ 44<sup>00</sup>

ONE KEY SYSTEM  
NICKEL, BRASS CYLINDER INSERT+  
CYLINDER INSERT-KNOB  
FOR DOOR THICKNESS 68MM  
SIZE 40/50

£ 48<sup>50</sup>



DOOR VIEWER  
NICKEL, PATINA  
FOR DOOR  
THICKNESS 55MM

£ 7<sup>50</sup>



CYLINDER INSERT-KNOB  
30G/50 AND 50G/30  
COLOUR NICKEL, PATINA  
FOR DOOR THICKNESS: 56MM

£ 15<sup>50</sup>

CYLINDER INSERT-KNOB  
40G/50 AND 50G/40  
COLOUR: NICKEL, PATINA  
FOR DOOR  
THICKNESS: 68MM (GRANDE)

£ 18<sup>00</sup>



DOOR VIEWER  
NICKEL, PATINA  
FOR DOOR  
THICKNESS  
60-90MM

£ 13<sup>00</sup>



# ACCESSORIES

## ADDITIONAL OPTIONS

STRAIGHT  
RECTANGULAR  
HANDLE  
BEVELLED,  
MOUNTED FROM  
OPPOSITED SIDES



LENGTH 1200 MM  
COLOUR: INOX

£ 271<sup>00</sup>

LENGTH 1500 MM  
COLOUR: INOX

£ 278<sup>50</sup>

LENGTH 1200 MM  
COLOUR: BLACK

£ 312<sup>00</sup>

LENGTH 1500 MM  
COLOUR: BLACK

£ 322<sup>50</sup>

STRAIGHT  
CYLINDRICAL  
HANDLE  
BEVELLED,  
MOUNTED FROM  
OPPOSITED SIDES



LENGTH 1200 MM  
COLOUR: INOX

£ 222<sup>50</sup>

LENGTH 1500 MM  
COLOUR: INOX

£ 230<sup>00</sup>

LENGTH 1200 MM  
COLOUR: BLACK

£ 252<sup>00</sup>

LENGTH 1500 MM  
COLOUR: BLACK

£ 261<sup>50</sup>



KICK PLATE  
8; 125 MM

£ 44<sup>00</sup>

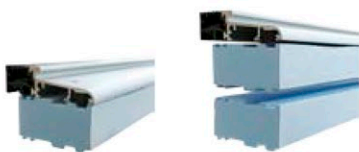

THRESHOLD FOUNDATION  
MEASUREMENTS:  
HEIGHT 30 MM  
WIDTH 60 MM  
LENGTH 1100 MM

£ 17<sup>50</sup>



CURVED DOOR HANDLE

LENGTH 1200 MM  
COLOUR: INOX

£ 227<sup>50</sup>



CURVER DOOR HANDLE

LENGTH 1200 MM  
COLOUR: BLACK

£ 256<sup>50</sup>



ELECTRICAL LOCK AVAILABLE  
FOR DOOR THICKNESS: 92, 68, 56 MM

£ 88<sup>00</sup>



MAGNETIC CONTACT

£ 39<sup>50</sup>

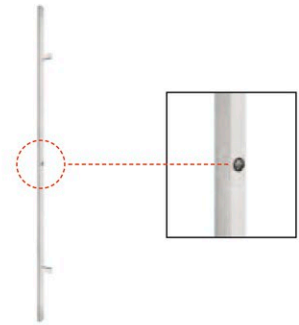

PRICE FOR DOOR HANDLE  
WITH BUTTON

£ 242<sup>00</sup>



ENERGO DOOR  
FRAME EXTENSION

25 MM £ 66<sup>00</sup>

50 MM £ 79<sup>00</sup>

100 MM £ 123<sup>00</sup>

SOLIDO DOOR  
FRAME EXTENSION

25 MM £ 57<sup>50</sup>

50 MM £ 70<sup>50</sup>

100 MM £ 92<sup>50</sup>

DRIP TRAY



STAINLESS STEEL CARE SPRAY

£ 22<sup>00</sup>



**Homeefe**  
DOORS · WINDOWS · FLOORING

17 The Precinct  
High Street South  
Rushden, NN100QU

Call our Sales Advisors

T: 07914 342 269

E: [office@homeefe.co.uk](mailto:office@homeefe.co.uk)

[www.homeefe.co.uk](http://www.homeefe.co.uk)